

DETALLES DE CHAFLANES. E 1/500
CH-1
CH-2
CH-3
CH-4
CH-5
CH-6
CH-7

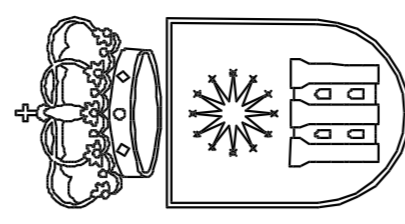
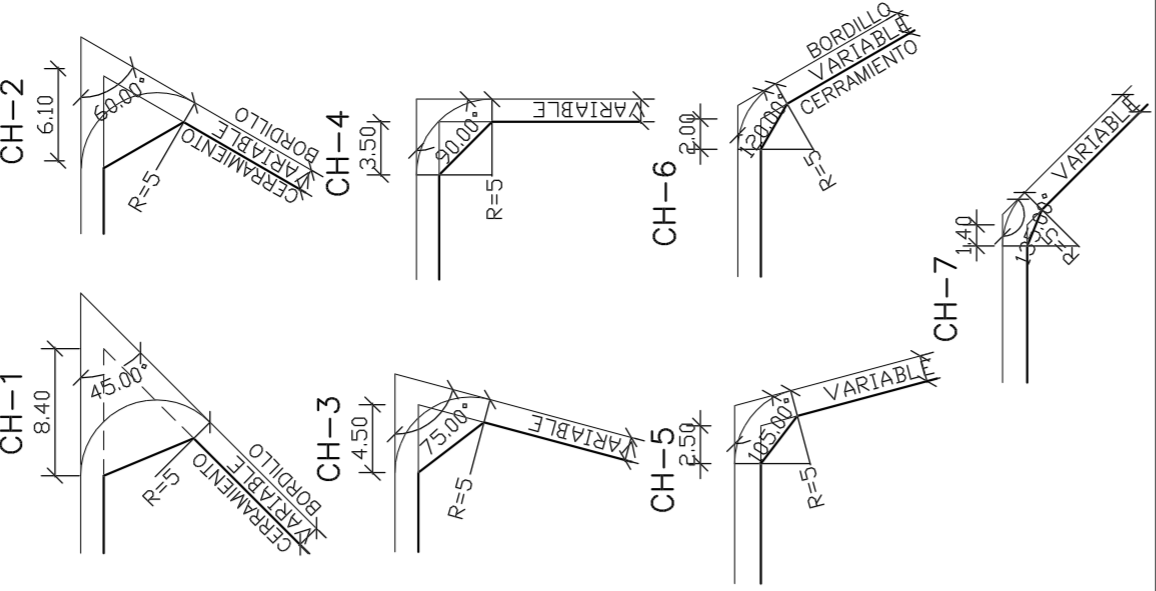

EXCMO. AYUNTAMIENTO
DE VILLAREJO DE
SALVANES (Madrid)

NORMAS SUBSIDIARIAS
DE PLANEAMIENTO
MUNICIPAL

ORDENACION

HOJA N°

3.C-3

REFERENCIA

97/43

FECHA

FEBRERO 2002

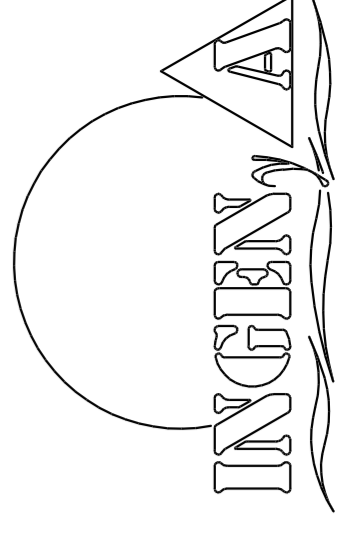

INGENIA
ARQUITECTURA ■ URBANISMO ■ INGENIERA
ORDENACION DEL TERRITORIO ■ MEDIO AMBIENTE
Tfno. 949-22 14 96 Fax. 949-21 47 82
C/ Amparo 53, 19002 Guadalajara

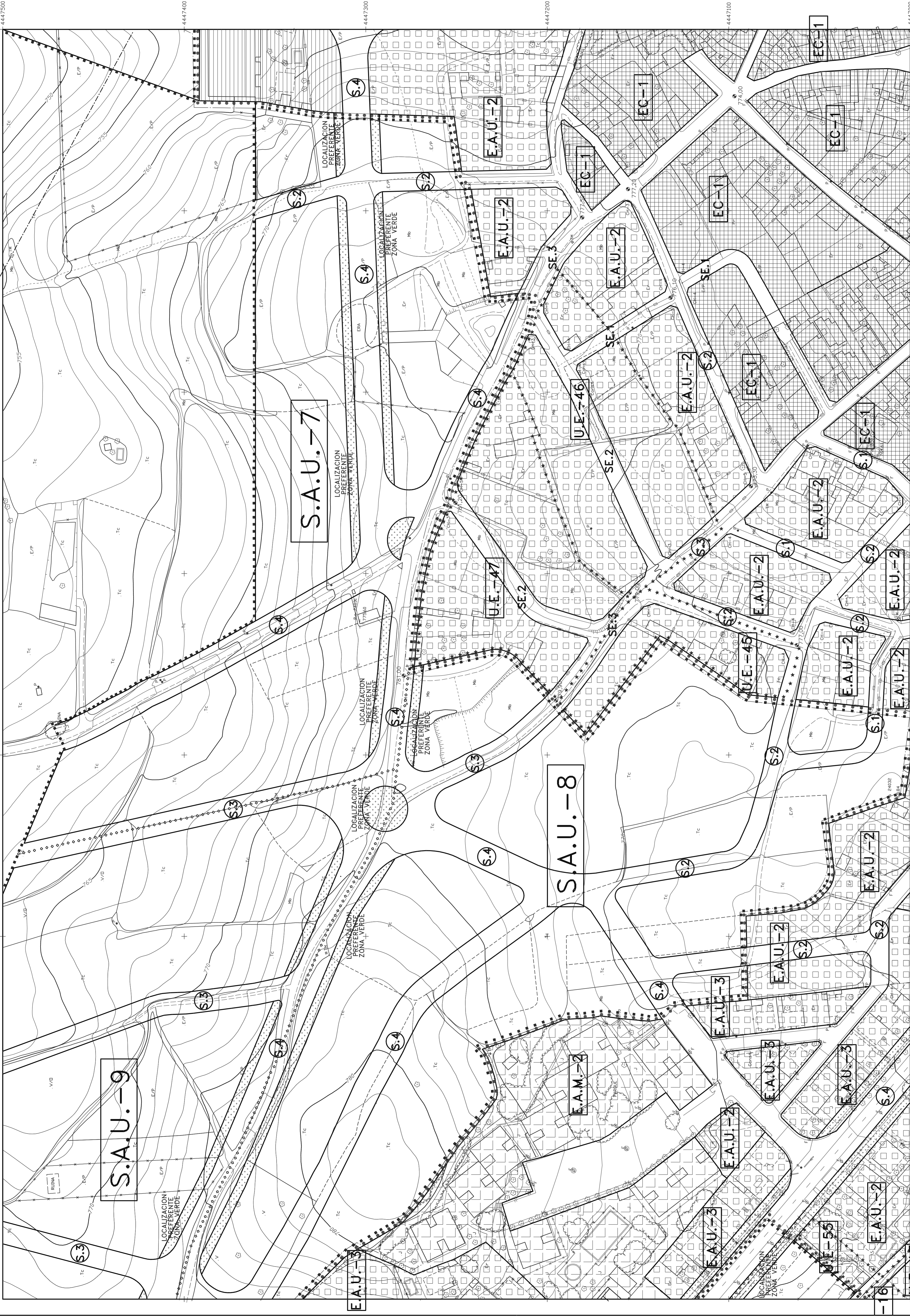

SUELO APTO PARA URBANIZAR

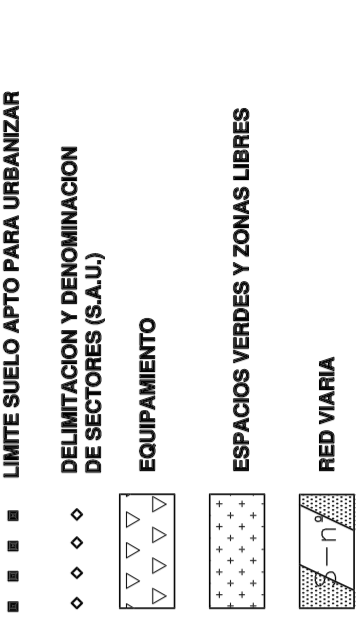

AMBITO DE PROTECCION ESPECIAL

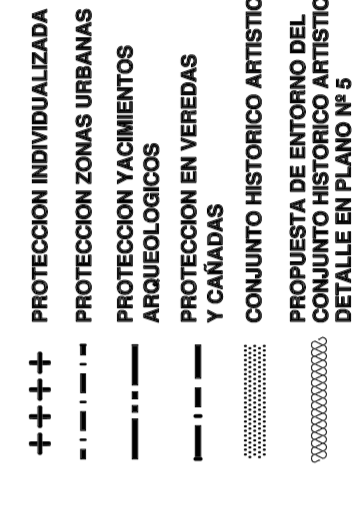

OTROS AMBITOS

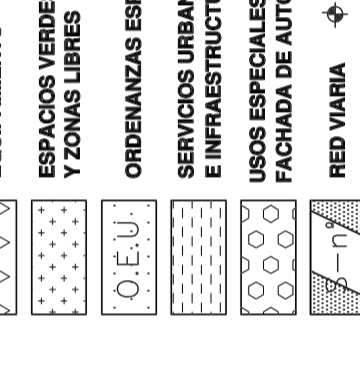

SUELO URBANO

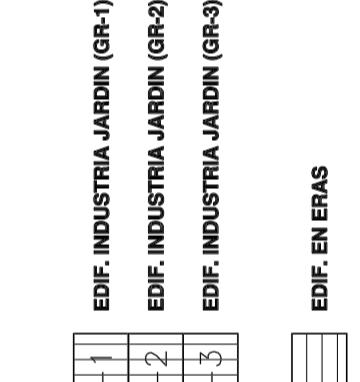

LOCALIZACION DE HOJAS

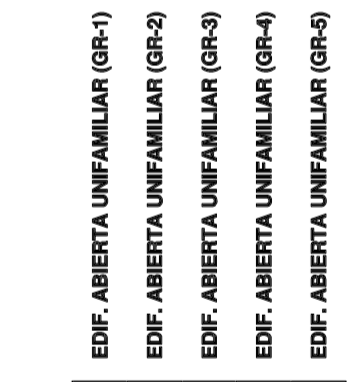

SUELO URBANO

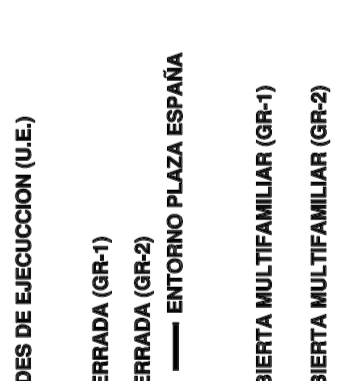

SUELO URBANO

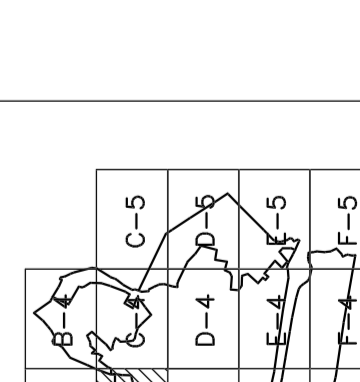

SUELO URBANO

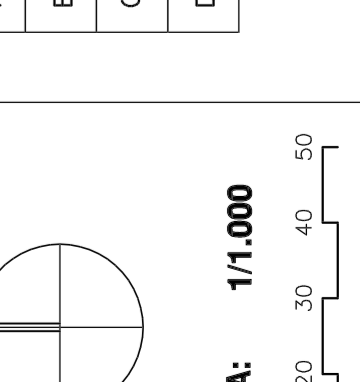

ESCALA: 1/1.000

